

# GREEN PRODUCT

REV.	ECN. NO.	LOCATIONS	DESCRIPTION	DATE	DESIGN
AO			初版發行	06/15'21	丁文靜

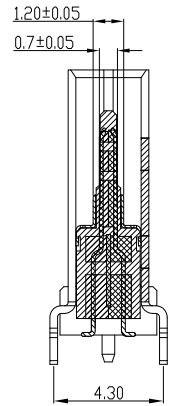
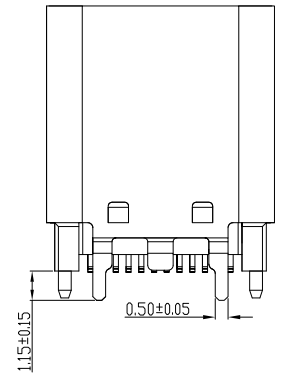
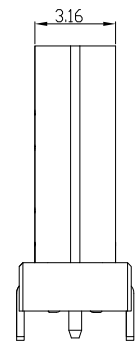
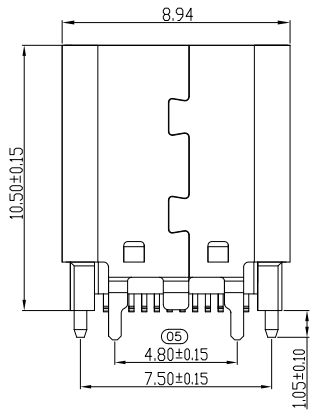
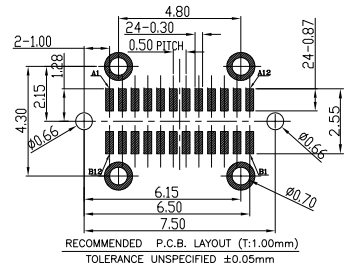
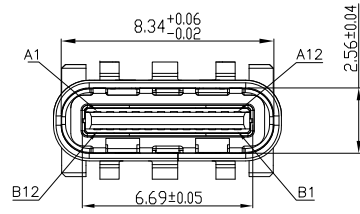

- 备注:
- 1.1 材质:
  - 1.2 端子: 高导电C7025, T=0.15mm; 镍底50U" MIN, 接触区域镀金 (AU 1u") 焊接区镀金G/F
  - 1.3 外壳: SUS304, T=0.30mm; 表面镀镍50U" MIN
  - 1.4 中夹片: SUS301, T=0.15mm;
  2. 主要特性:
  - 2.1 额定电流: 5A
  - 2.2 接触阻抗: 40mΩ MAX (初始值) 50mΩ MAX (测试后)
  - 2.3 绝缘阻抗: 100MΩ MIN
  - 2.4 耐压测试: 100V AC R. M. S.
  - 2.6 整体插入力: 5-20N 整体插入力: 5-20N (耐久后) 整体拔出力: 8-20N 整体拔出力: 6-20N (耐久后)
  - 2.7 耐久: 10000次
  - 2.8 耐高温: SMT回流焊 (峰值260° ±5°), 塑胶不能有起泡, 融胶等不良, 变色, 翘曲变形在公差范围以内;
  - 2.9 产品须做焊锡测试, 粘锡面积达到95%以上;
  - 3.0 盐雾测试: 48H MIN
  - 3.1 工作温度: -30℃ ~ +85℃

PIN NUMBER	SIGNAL NAME	PIN NUMBER	SIGNAL NAME
A1	GND	B12	GND
A2	SSTXp1	B11	SSRXp1
A3	SSTXn1	B10	SSRXn1
A4	VBUS	B9	VBUS
A5	CC1	B8	SBU2
A6	Dp1	B7	Dn2
A7	Dn1	B6	Dp2
A8	SBU1	B5	CC2
A9	VBUS	B4	VBUS
A10	SSRXn2	B3	SSTXn2
A11	SSRXp2	B2	SSTXp2
A12	GND	B1	GND

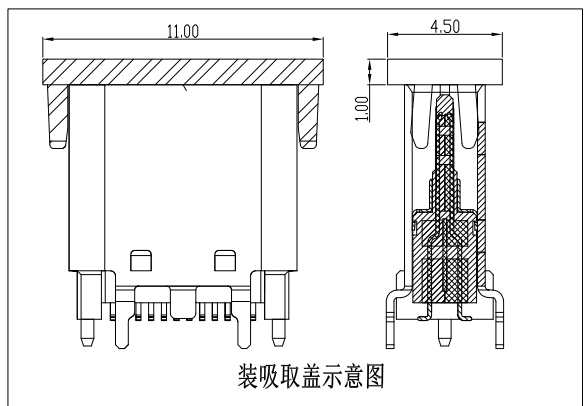
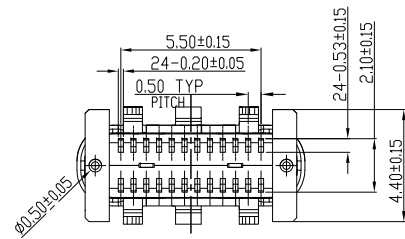

INTENDED USE	UNIT mm			東莞康祥電子有限公司	
PART NO.	FINISH			DONG GUAN KANG XIANG ELECTRON CO.,LTD.	
TOLERANCES	MAT'L	APPD:	TITLE:	TYPE C FEMALE 24P 立貼 H10.5 帶小脚	
.X ± 0.35 X.* ± 3.0°		CHKD:	FILE NO.	REV.	AO
.XX ± 0.25 X.X' ± 1.5°	SEE NOTE	DR: 程念念 06/15'21	SCALE N/A	SHEET 1 OF 1	